

Introduction

The 'ApplePie' range by Ekol.

Whether it be for a boat, yurt, glamping pod, shepherd's hut or just a compact fireplace, 'ApplePie' can be adapted and customised to suit. With its very low distance to combustibles this stove is ideal for small spaces.

With its individual styling and multiple cooking options including stainless cooktop, top baking oven, pan supports to one or both sides as well as griddle plate and pizza shelf inside, the ApplePie is the 'Swiss Army Knife' of wood burning stoves.

Amongst an elite handful of small-space stoves fully compliant with DEFRA and Ecodesign 2022 it can be used to burn wood anywhere in the UK.

With full cast iron construction and weighing in heavier than many stoves more than twice its size, it really is built to last.

Primary, Secondary and Tertiary air are intuitively controlled by a single air control and with an extra large window, enthusiastic fire-starters and chefs can easily monitor their creations.



Technical Specification

- EcoDesign 2022 Ready (future proofed)
- 82% Efficient
- 4 kW Nominal Heat Output
- Optimal Heat Output Range 1- 4 kW
- 10 Year Warranty
- DEFRA Exempt / Approved for Smoke Control Areas
- Ultra-Clean-Burning
- Superior Air-wash System for Crystal-Clear Views
- Full Cast Iron Construction
- Includes Grate
- Can be used with 4" Top or Vertical Rear Flue Outlet
- Suitable for use on a 12mm Hearth
- Internal and External Cooking Options
- Optional External Air
- Intuitive Single Air Control
- Includes removable Pizza / Griddle Shelf
- Low Distance to Combustibles

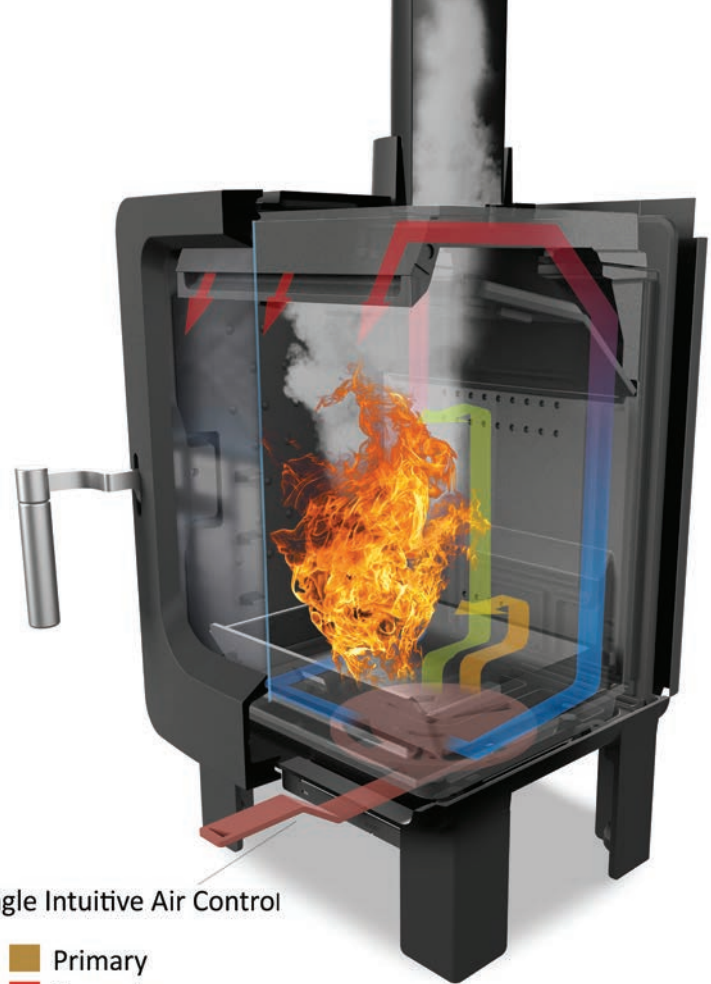

Single Intuitive Air Control

- Primary
- Secondary
- Tertiary

Inside...





Or outside.

(we recommend shelter from direct rain)

A cozy indoor scene featuring a wood-burning stove with a fire, a wooden table with a mug, a basket of yarn, and a wooden chair. The stove is white with a black top and a glass door showing a bright fire. To the right, a wicker basket contains a ball of purple and grey yarn, a pair of knitting needles, and a colorful knitted scarf. On the wooden table in the foreground, there is a brown ceramic mug and a spool of white twine. A wooden chair with a curved back is visible in the lower left. The background is a dark, textured wall.

Cooking, Heating or both.

Versatility as Standard.



Choose your model

Brushed stainless steel and hardwood handles included with every stove.
Internal (removable) pizza / griddle shelf included with every stove.

Apple Core



Apple Stack



Baked Apple



Baked Apple Stack



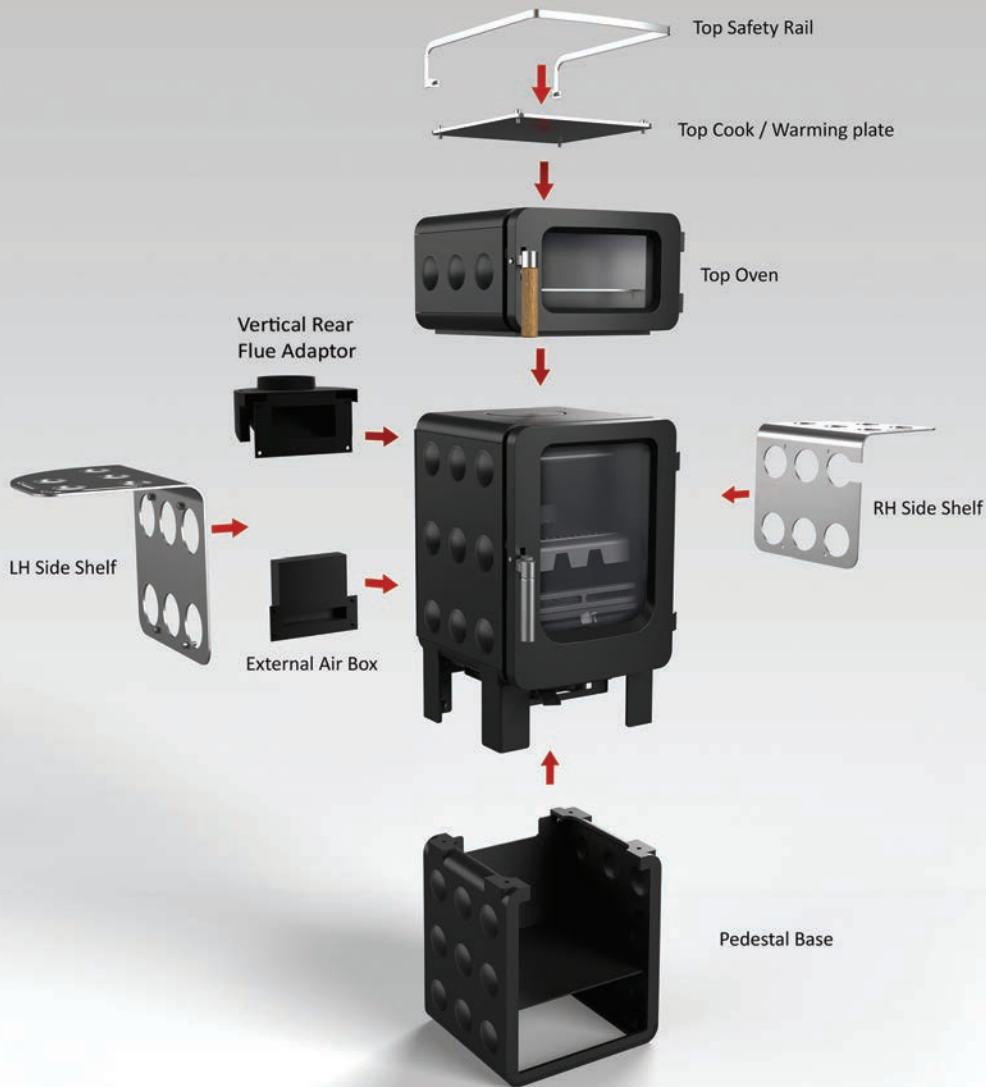

Optional Extras

- Pot / Pan Safety Rail
- Top Cooking or Warming Plate
- Top Oven
- Left Side Plate
- Right Side Plate
- Pedestal / Store
- External Air Inlet
- Vertical Rear Flue Outlet
- Small or Large Enclosures
- Colour Options Available



One Stove, Modular Options.



Make Your Small Space Unique.

Short Enclosure



Off the Top Flue



Vertical Rear Flue Adaptor

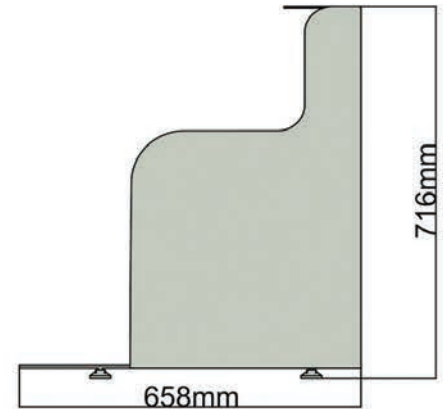
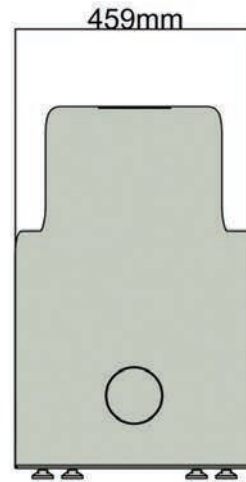
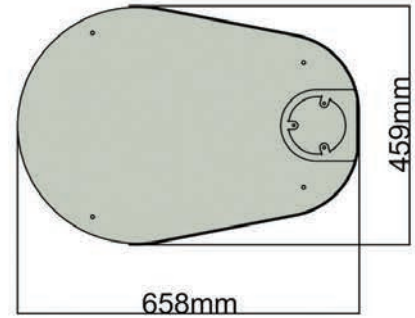

Tall Enclosure

Off the Top Flue



Vertical Rear Flue Adaptor

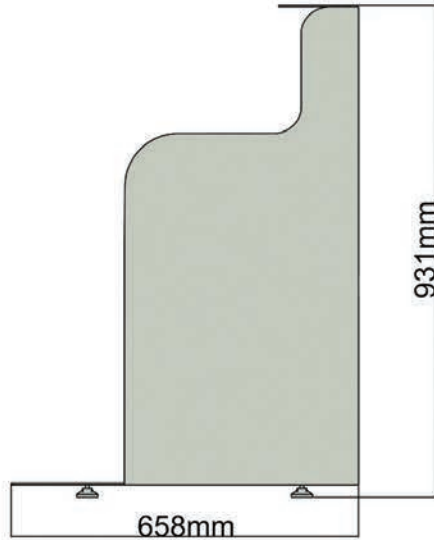
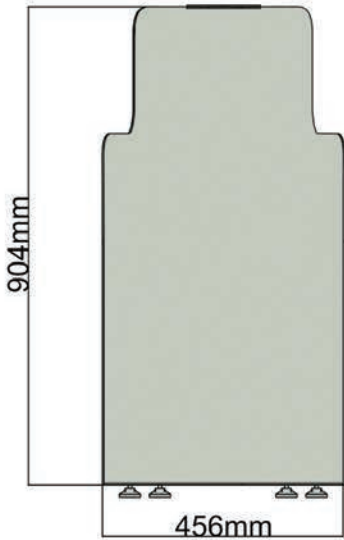
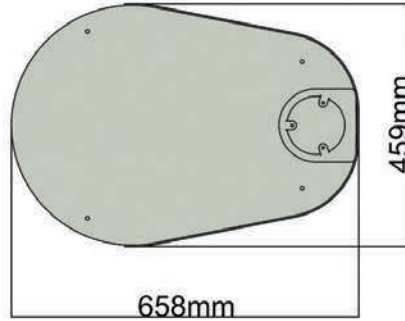



Distance to Combustibles



SINGLE WALL FLUE Standard Configuration

Back Wall: 250mm
Side Wall: 350mm

(210 mm from back of stove to wall
when used without Vertical Rear Flue Adaptor)

* Distances from flue to wall need separate consideration
based on local regulations and flue designation



TWIN WALL FLUE Standard Configuration

Back Wall: 50mm
Side Wall: 300mm

(100 mm from back of stove to wall
when used without Vertical Rear Flue Adaptor)



TWIN WALL FLUE Corner Configuration

Left Side Wall: 150mm
Right Side Wall: 150mm

(Observe same distances when using
top outlet and twinwall)

Distances can be reduced further with adjacent shielding on the wall. (Contact us for details)

Stove Internals

(included with every stove)



Reversible Pizza Shelf / Giddle Plate



Removable Grate and Log Retainer Bar



Heavy Duty Burn Tray / Ashpan
(Wood can be burnt directly in tray)



Multitool



Top Oven

- Ideal for cooking, baking and warming food.
- Adjustable shelf height to allow for various size pots and baking trays.
- Reaches temperatures in excess of 200 °C
- Includes both Brushed Stainless Steel and hardwood Handles
- Optional body and door colours available.



Bake...



Boil & Simmer...

Fry...



Griddle...



Optional Body and door colours (actual product colours may vary from colours shown)

Metallic
Black

Charcoal
Grey

Light
Grey

Metallic
Blue

Patriot
Blue

Almond

Mojave
Red

Apple
Green

Green
Illusion

Burnished
(Door Only)

Apple Stack

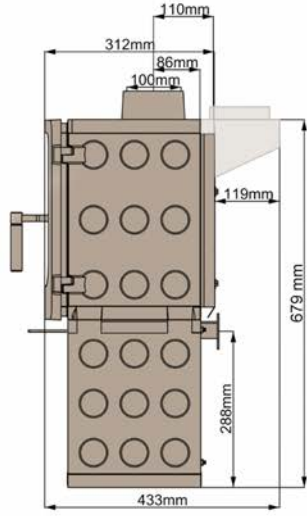
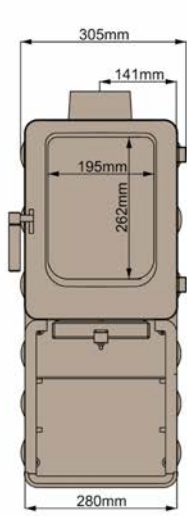

Apple Core

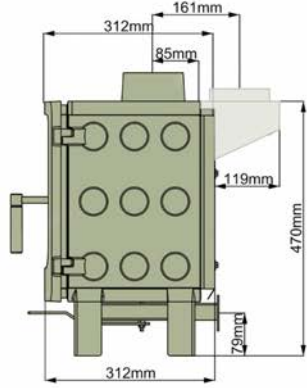
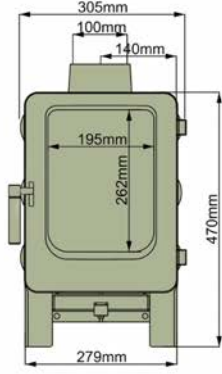

Baked Apple Stack

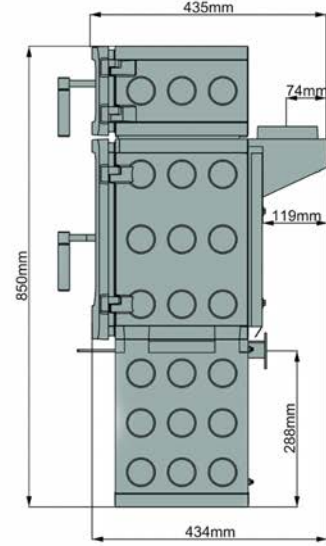
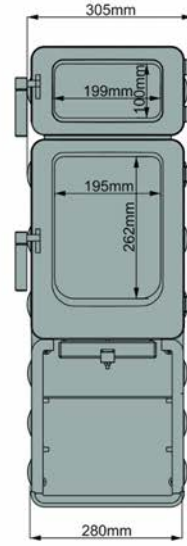



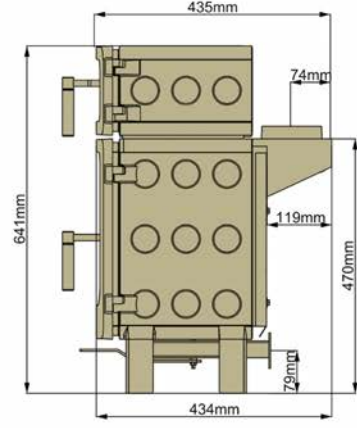
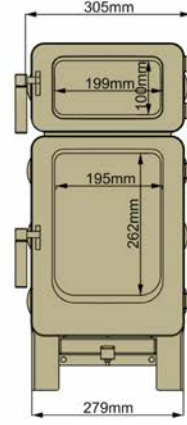







Baked Apple Core



Configure Your ApplePie Stove

Step 4- Additional Options

Step 1 Select your Model	Step 2 Select Body colour	Step 3 Select Door colour	 Top Cook Plate	 Pot Safety Rail	 Left Hand Side Shelf	 Right Hand Side Shelf	 External Air Box	 Vertical Rear Flue Outlet	 Stove Enclosure
 Apple Core									
 Baked Apple								already Included	
 Apple Stack									
 Baked Apple Stack								already Included	

Colour options (please write your chosen colours in boxes provided above)

Metallic Black

Charcoal Grey

Light Grey

Metallic Blue

Patriot Blue

Almond

Mojave Red

Apple Green

Green Illusion

Burnished (Door Only)

Additional Notes





Thank you for taking the time to consider an Ekol ApplePie Stove. We understand that choosing the right stove can be an important decision.

If you would like any guidance at all, please contact either your local Ekol ApplePie specialist or you are more than welcome to contact us directly for any information or support.

Your new Ekol ApplePie will come with 10 years body warranty for peace of mind, and technical support forever should you need it.

The ApplePie range of options will continue to expand - if there is a variation or design option you would like but cannot see in the brochure, you can contact us or take a look at the website for new design options as they emerge.

Visit www.applepiestove.com

For details of your nearest specialist retailer and to see which models they have on display, simply enter your postcode on the website www.defrastoves.com

Here at Ekol we can be contacted directly by email at sales@defrastoves.com, or by telephone on (UK) +44(0)1929 555211.



www.applepiestove.com www.defrastoves.com Tel: 01929 555211